

## Datasheet

# Economic 802.3af/at PoE Switch

WI-PS205H | WI-PS210H | WI-PS518GH | WI-PS526GH  
 WI-PS305GH | WI-PS308GH | WI-PS309GFH  
 WI-PS318GFH | WI-PS326GFH



## Overview

Wi-Tek's Economic 802.3af/at PoE Switch Series offers a choice of 4/8/16/24 ports, available in both 100Mbps and 1000Mbps speeds. Break free from PoE distance limitations! Wi-Tek provides a cost-effective PoE solution, empowering your CCTV, Access Point, and other IP-based devices up to 250m away. Most robust features like Extend Mode, PoE Watchdog Function, Port Isolation, provide a lot of value for basic networking needs, creating a versatile and reliable surveillance network to grow your business.

## Features

### PoE 250m Long Distance to Extend Network

DIP switch provides Extend Mode. All PoE ports can transmit data and power up to 250 meters. No further hardware or configuration is necessary, easy-to-use and cost-saving. Perfect for surveillance camera deployment in large areas.

### Smart PoE Watchdog to Reboot Camera Automatically

All PoE ports enable PoE watchdog function, which can detect and reboot the offline compliant PoE powered devices.

### Port Isolation to Prevent Broadcast Storm

With VLAN Mode, all PoE ports only can communicate with uplink ports. Avoid data leakage between each port and prevent broadcast storm from disabling network.

### Double Uplink to Eliminate the Bandwidth Limit

Uplink ports superficially resembles any other normal port on a switch or hub. Additionally, connecting the uplink port on one switch to the normal port on another switch cab helps expand the size of the network.

### DIP – Data Optimization

Default: The transmission distance of PoE port can be up to 100m with 100Mbps.

VLAN: Enable isolation between all downstream ports, while maintaining data communication with the upstream port, effectively preventing broadcast storms.

Extend: Extend the power supply and network transmission distance of PoE ports from the standard 100m to an impressive 250m, though with a reduced port rate of 10Mbps. Elevate your networking experience with enhanced flexibility and efficiency.

CCTV: Extend your network up to 250 meters long distance with VLAN function.

# Specifications



Model	WI-PS205H	WI-PS210H	WI-PS518GH	WI-PS526GH
Hardware Specifications				
Hardware Version	V2	V1	V1	V1
Interfaces				
Downlink Ports	4 * 100Mbps RJ45 PoE Ports	8 * 100Mbps RJ45 PoE Ports	16 * 100Mbps RJ45 PoE Ports	24 * 100Mbps RJ45 PoE Ports
Uplink Ports	2 * 100Mbps RJ45 Ports	2 * 100Mbps RJ45 Ports	1 * 1000Mbps RJ45 Port 1 * 1000Mbps Combo Port	1 * 1000Mbps RJ45 Port 1 * 1000Mbps Combo Port
PoE				
PoE Port	Port 1 – 4	Port 1 – 8	Port 1 – 16	Port 1 – 24
PoE Standard	802.3 af/at			
PoE Power Supply Type	End-span			
PoE Pin Assignment	1/2(+), 3/6(-)			
PoE Power	30W Max. for each port, 42W Max. for PoE power budget	30W Max. for each port, 62W Max. for PoE power budget	30W Max. for each port, 197W Max. for PoE power budget	30W Max. for each port, 198W Max. for PoE power budget
Switch Property				
Standards and Protocols	IEEE 802.3, IEEE 802.3u, and IEEE 802.3x		IEEE 802.3, IEEE 802.3u, and IEEE 802.3x, IEEE 802.3z	
Forwarding Mode	Store and Forward			
Switching Capacity	1.2 Gbps	2 Gbps	7.2 Gbps	8.8 Gbps
Packet Forwarding Rate	0.89Mpps	1.49Mpps	5.36Mpps	6.55Mpps
MAC Address Table	2k	2k	8k	8k
Packet Buffer Memory	448 K bit		4M bit	
Jumbo Frame	1.5 kB		10 kB	
Power Supply				
Input Power	100–240 V AC 50/60 Hz 1.5A max	100–240 V AC 50/60 Hz 1.5A max	100–240 V AC 50/60 Hz 5A max	100–240 V AC 50/60 Hz 5A max
Power Consumption	Idle: 1.83 W 100% Traffic Rate with PoE: 44 W	Idle: 2.41 W 100% Traffic Rate with PoE: 65.7 W	Idle: 7.79 W 100% Traffic Rate with PoE: 205 W	Idle: 8.02 W 100% Traffic Rate with PoE: 206.6 W



Model	WI-PS205H	WI-PS210H	WI-PS518GH	WI-PS526GH
<b>Physical Characteristics</b>				
LED Indicators	<p><b>Power</b> On: The device power on is normal Off: The device is power off or failed</p> <p><b>PoE</b> On: PoE is working Off: PoE not working</p> <p><b>DATA</b> Blinking: Data transmission is active and working</p> <p><b>LNK/ACT</b> On: Data on TX/RX Off: Ports link down</p>	<p><b>PWR</b> On: The device power on is normal Off: The device is power off or failed</p> <p><b>PoE</b> On: PoE is working Off: PoE not working</p> <p><b>DATA</b> Blinking: Data transmission is active and working</p> <p><b>Max</b> When total PoE output power &gt; Power Budget * 80%, the LED light will be on</p> <p><b>LNK/ACT</b> On: Data on TX/RX Off: Ports link down</p>	<p><b>PWR</b> On: The device power on is normal Off: The device is power off or failed</p> <p><b>PoE</b> On: PoE is working Off: PoE not working</p> <p><b>DATA</b> Blinking: Data transmission is active and working</p> <p><b>PoE Max</b> When total PoE output power &gt; Power Budget * 80%, the LED light will be on</p> <p><b>LNK/ACT</b> On: Data on TX/RX Off: Ports link down</p> <p>18T On: Port 18 link up Off: Port 18 link down</p> <p><b>17T/17S</b> On: Port 17T/17S link up Off: Port 17T/17S link down</p>	<p><b>PWR</b> On: The device power on is normal Off: The device is power off or failed</p> <p><b>PoE</b> On: PoE is working Off: PoE not working</p> <p><b>DATA</b> Blinking: Data transmission is active and working</p> <p><b>PoE Max</b> When total PoE output power &gt; Power Budget * 80%, the LED light will be on</p> <p><b>LNK/ACT</b> On: Data on TX/RX Off: Ports link down</p> <p><b>25T</b> On: Port 25 link up Off: Port 25 link down</p> <p><b>26T/26S</b> On: Port 26T/26S link up Off: Port 26T/26S link down</p>
Fan Quantity	Fanless		1	
Dimensions (W*D*H)	140x82x28 mm	167x99x33 mm	281x188x44 mm	281x188x44 mm
Weight	Net Weight: 0.32 kg	Net Weight: 0.47 kg	Net Weight: 1.75 kg	Net Weight: 1.82 kg
	Package Weight: 0.60 kg	Package Weight: 0.77 kg	Package Weight: 2.37 kg	Package Weight: 2.45 kg
Installation	Desktop		Desktop、 Rack-mount	
<b>Button</b>				
DIP Switch	Default/CCTV (CCTV=250m Extend mode + VLAN mode)	Default/CCTV (CCTV=250m Extend mode + VLAN mode)	Default/VLAN/CCTV (CCTV=250m Extend mode + VLAN mode)	Default/VLAN/Extend (CCTV=250m Extend mode + VLAN mode)



Model		WI-PS205H	WI-PS210H	WI-PS518GH	WI-PS526GH
Environmental					
Reliability	Surge Immunity	EC 61000-4-5 Common mode ±4kV Differential mode ±2kV			
	ESD Protection	IEC 61000-4-2 Contact discharge ±6kV Air discharge ± 8kV			
Operating Temperature		-10°C to 55°C(14°F to 131°F)			
Operating Humidity		10%-90% RH no condensation			
Storage Temperature		-40°C to 70°C(-40°F to 158°F)			
Storage Humidity		5%-90% RH no condensation			
Others					
Certification		CE, FCC, RoHS, UKCA, RCM			
Network Media		10Base-T: Pair 2 Category 3 (cat 3 ) and above UTP/ STP(≤100m) 100Base-TX: Pair 2 Category 5 (cat 5 ) and above UTP/ STP(≤100m)		10Base-T: Pair 2 Category 3 (cat 3 ) and above UTP/ STP(≤100m) 100Base-TX: Pair 2 Category 5 (cat 5 ) and above UTP/ STP(≤100m) 1000BASE-TX: 6 Category and above UTP(≤100m)	





Model	WI-PS305GH	WI-PS308GH	WI-PS309GFH	WI-PS318GFH	WI-PS326GFH
<b>Hardware Specifications</b>					
Hardware Version	V1	V2	V1	V1	V1
<b>Interfaces</b>					
Downlink Ports	4 1000Mbps RJ45 PoE Ports	8 1000Mbps RJ45 PoE Ports	8 1000Mbps RJ45 PoE Ports	16 1000Mbps RJ45 PoE Ports	24 1000Mbps RJ45 PoE Ports
Uplink Ports	1 1000Mbps RJ45 Port	2 1000Mbps RJ45 Ports	1 1000Mbps RJ45 Ports 1 1000Mbps SFP Port	2 1000Mbps Combo Ports	2 1000Mbps SFP Slots
<b>PoE</b>					
PoE Port	Port 1– 4	Port 1– 8	Port 1– 8	Port 1– 16	Port 1– 24
PoE Standard	802.3 af/at				
PoE Power Supply Type	End-span				
PoE Pin Assignment	1/2(+), 3/6(-)				
PoE Power	30W Max. for each port, 57W Max. for PoE power budget	30W Max. for each port, 62W Max. for PoE power budget	30W Max. for each port, 64W Max. for PoE power budget	30W Max. for each port, 197W Max. for PoE power budget	30W Max. for each port, 252W Max. for PoE power budget
<b>Switch Property</b>					
Standards and Protocols	IEEE 802.3, IEEE 802.3u, IEEE 802.3x, IEEE 802.3ab, and IEEE 802.3z				
Forwarding Mode	Store and Forward				
Switching Capacity	10 Gbps	20 Gbps	20 Gbps	36 Gbps	52 Gbps
Packet Forwarding Rate	7.44 Mpps	14.88 Mpps	14.88 Mpps	26.78 Mpps	38.69 Mpps
MAC Address Table	2k	4k			8k
Packet Buffer Memory	1 Mbit	2 Mbit	1.5 Mbit	4.1 Mbit	4.1 Mbit
Jumbo Frame	10 kB				
<b>Power Supply</b>					
Input Power	100–240 V AC 50/60 Hz 1.5A max			100–240 V AC 50/60 Hz 5A max	100–240 V AC 50/60 Hz 5A max
Power Consumption	Idle: 2.38 W 100% Traffic Rate with PoE: 59.4 W	Idle: 3.32 W 100% Traffic Rate with PoE: 65.6 W	Idle: 3.13 W 100% Traffic Rate with PoE: 67.8 W	Idle: 10.3 W 100% Traffic Rate with PoE: 207.3 W	Idle: 21.1 W 100% Traffic Rate with PoE: 273.5 W



Model	WI-PS305GH	WI-PS308GH	WI-PS309GFH	WI-PS318GFH	WI-PS326GFH
<b>Physical Characteristics</b>					
LED Indicators	<p><b>Power</b> On: The device power on is normal Off: The device is power off or failed</p> <p><b>PoE</b> On: PoE is working Off: PoE not working</p> <p><b>DATA</b> Blinking: Data transmission is active and working</p> <p><b>LNK/ACT</b> On: Data on TX/RX Off: Ports link down</p>	<p><b>PWR</b> On: The device power on is normal Off: The device is power off or failed</p> <p><b>PoE</b> On: PoE is working Off: PoE not working</p> <p><b>DATA</b> Blinking: Data transmission is active and working</p> <p><b>LNK/ACT</b> On: Data on TX/RX Off: Ports link down</p>	<p><b>Power</b> On: The device power on is normal Off: The device is power off or failed</p> <p><b>PoE</b> On: PoE is working Off: PoE not working</p> <p><b>DATA</b> Blinking: Data transmission is active and working</p> <p><b>LNK/ACT</b> On: Data on TX/RX Off: Ports link down</p>	<p><b>PWR</b> On: The device power on is normal Off: The device is power off or failed</p> <p><b>PoE</b> On: PoE is working Off: PoE not working</p> <p><b>DATA</b> Blinking: Data transmission is active and working</p> <p><b>PoE Max</b> When total PoE output power &gt; Power Budget * 80%, the LED light will be ON</p> <p><b>LNK/ACT</b> On: Data on TX/RX Off: Ports link down</p>	<p><b>PWR</b> On: The device power on is normal Off: The device is power off or failed</p> <p><b>PoE</b> On: PoE is working Off: PoE not working</p> <p><b>DATA</b> Blinking: Data transmission is active and working</p> <p><b>PoE Max</b> When total PoE output power &gt; Power Budget * 80%, the LED light will be ON</p> <p><b>LNK/ACT</b> On: Data on TX/RX Off: Ports link down</p>
Fan Quantity	Fanless			1	2
Dimensions (W*D*H)	140x82x28 mm	168x99x33 mm	168x99x33 mm	281x185x44 mm	442x213x44 mm
Weight	Net Weight: 0.36 kg	Net Weight: 0.52 kg	Net Weight: 0.51 kg	Net Weight: 1.84 kg	Net Weight: 2.47 kg
	Package Weight: 0.64 kg	Package Weight: 0.81 kg	Package Weight: 0.82 kg	Package Weight: 2.48 kg	Package Weight: 3.27 kg
Installation	Desktop			Desktop、 Rack-mount	
<b>Button</b>					
DIP Switch	Default/CCTV(CCTV=250m Extend mode + VLAN mode)				
<b>Environmental</b>					
Reliability	Surge Immunity	EC 61000-4-5 Common mode ±4kV Differential mode ±2kV			
	ESD Protection	IEC 61000-4-2 Contact discharge ±6kV Air discharge ± 8kV			
Operating Temperature	-10°C to 55°C(14°F to 131°F)				
Operating Humidity	10%~90% RH no condensation				
Storage Temperature	-40°C to 70°C(-40°F to 158°F)				
Storage Humidity	5%~90% RH no condensation				



Model	WI-PS305GH	WI-PS308GH	WI-PS309GFH	WI-PS318GFH	WI-PS326GFH
Others					
Certification	CE, FCC, RoHS, UKCA, RCM				
Network Media	10Base-T: Pair 2 Category 3 (cat 3 ) and above UTP/ STP(≤100m) 100Base-TX: Pair 2 Category 5 (cat 5 ) and above UTP/ STP(≤100m) 1000BASE-TX: 6 Category and above UTP(≤100m)				



# Appearances and Dimensions

WI-PS205H

Dimensions (mm)

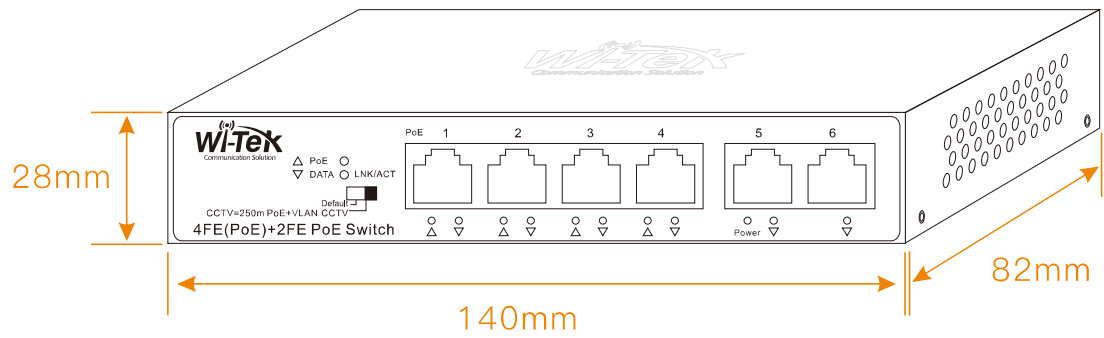

Front Panel

Rear Panel

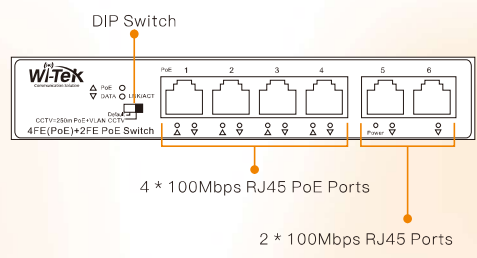



WI-PS210H

Dimensions (mm)

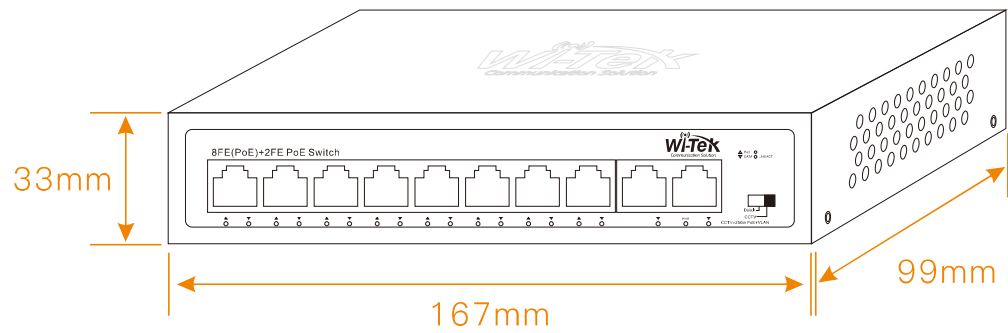

Front Panel

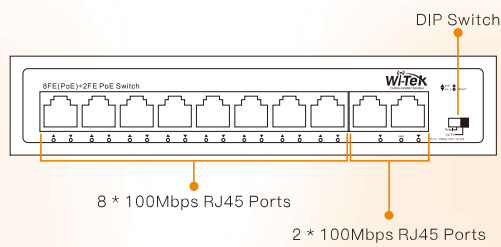

Rear Panel

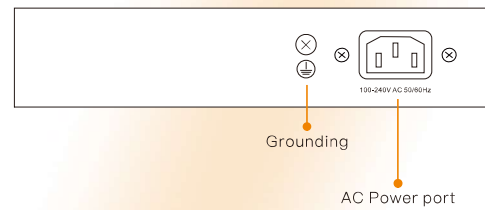

WI-PS518GH

Dimensions (mm)

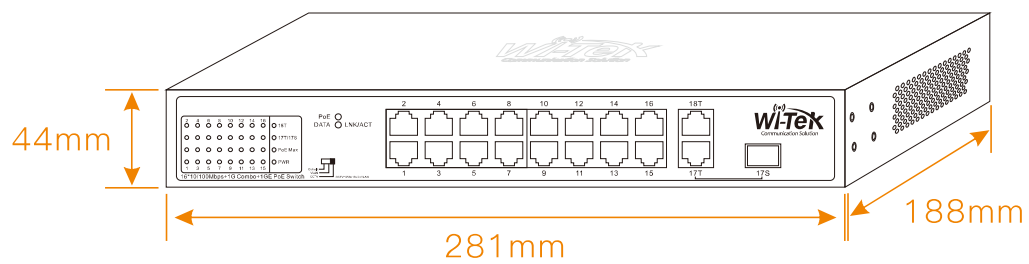

Front Panel

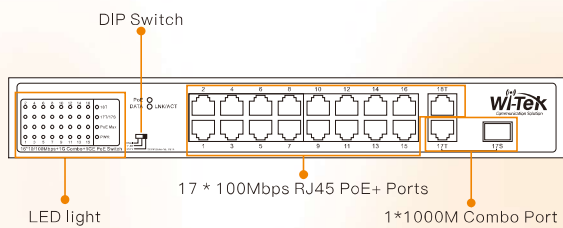

Rear Panel

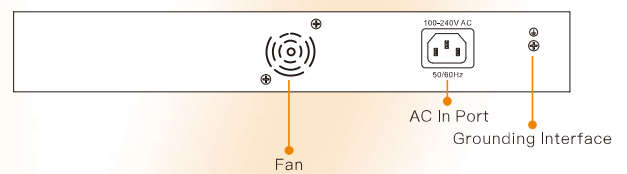

WI-PS526GH

Dimensions (mm)

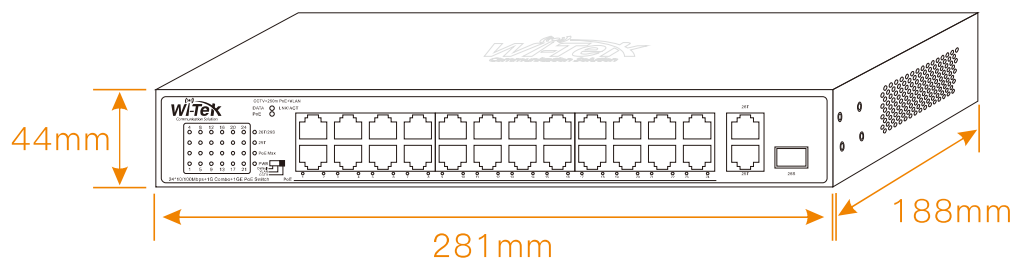

Front Panel

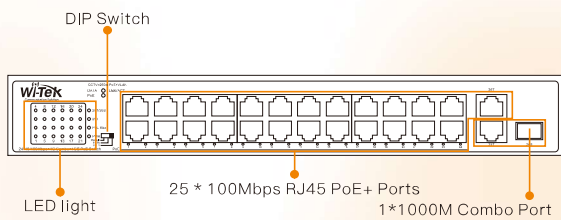

Rear Panel

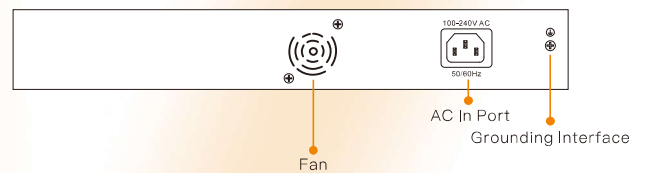

WI-PS305GH

Dimensions (mm)

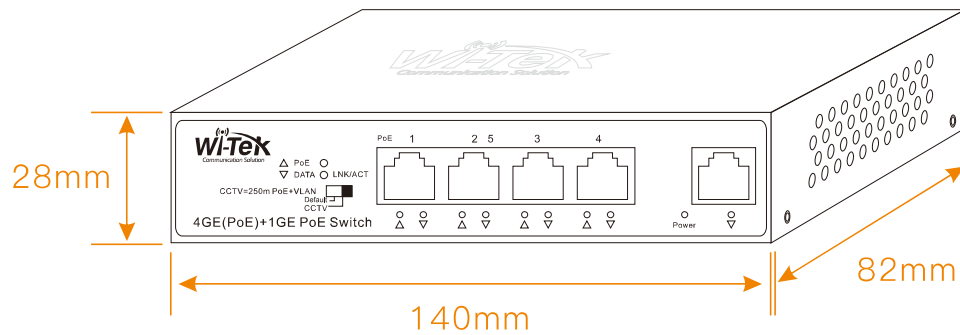

Front Panel

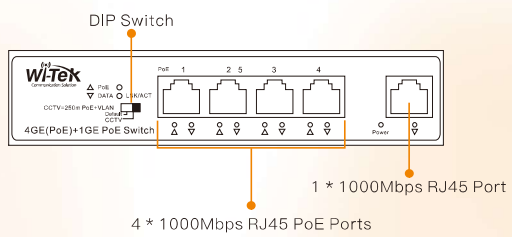

Rear Panel

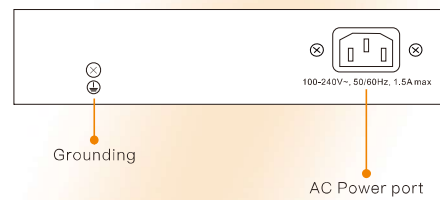

WI-PS308GH

Dimensions (mm)

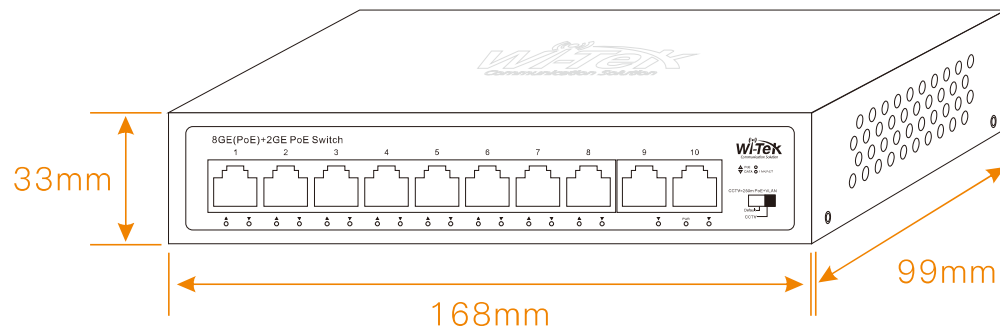

Front Panel

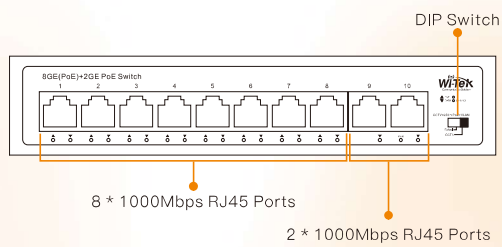

Rear Panel

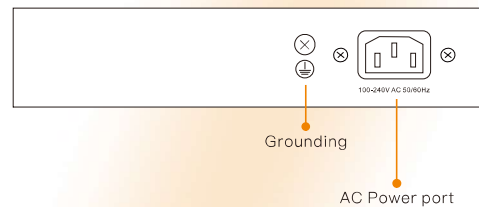

WI-PS309GFH

Dimensions (mm)

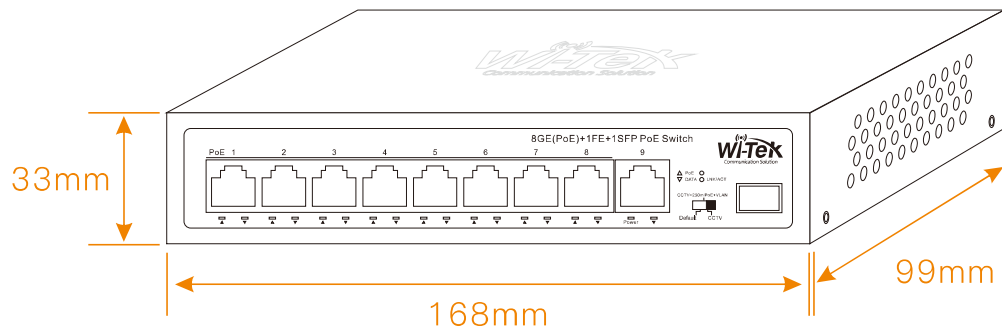

Front Panel

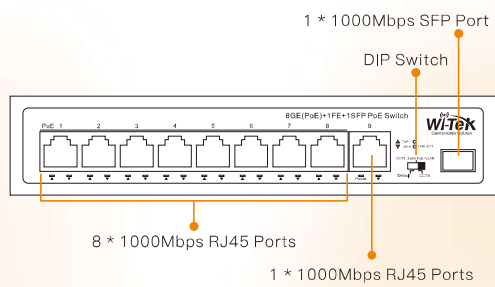

Rear Panel

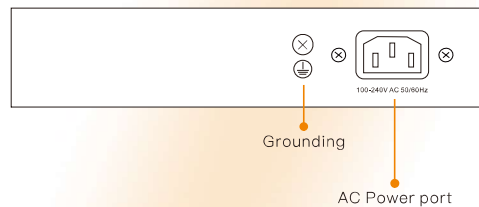

WI-PS318GFH

Dimensions (mm)

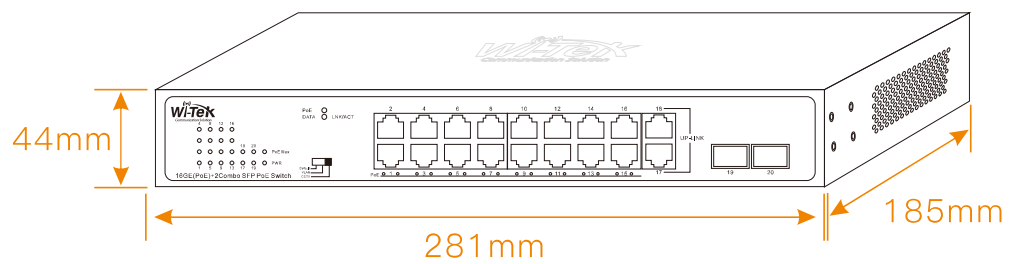

Front Panel

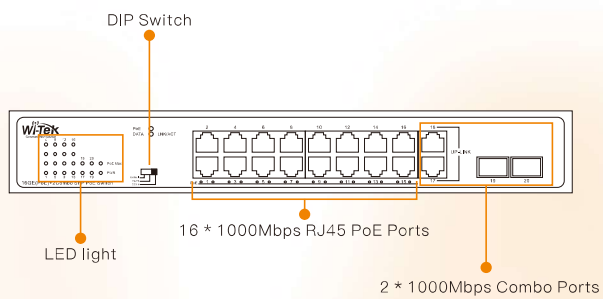

Rear Panel

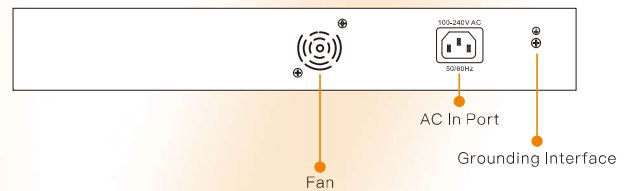

WI-PS326GFH

Dimensions (mm)

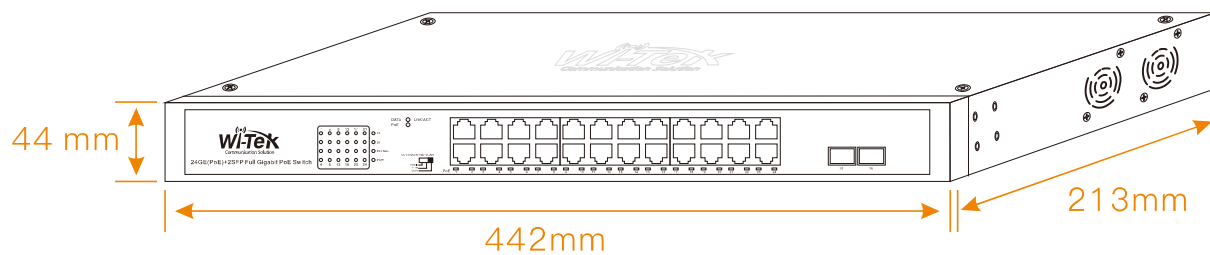

Front Panel

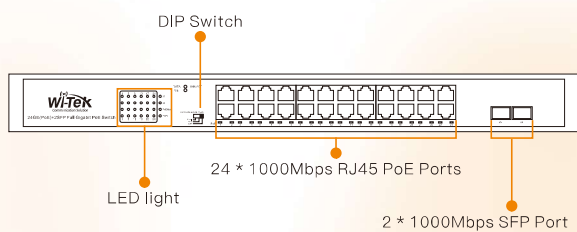

Rear Panel

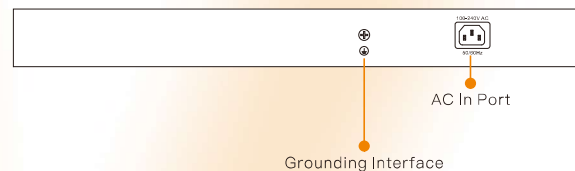



## Package Contents

Welcome to order our products. After purchasing, you will receive:

WI-PS205H   WI-PS305GH	
Items	Quantity
Switch	1 pcs
AC Power Cord	1 pcs
Quick Installation Guide	1 pcs
WI-PS210H   WI-PS308GH   WI-PS309GFH	
Items	Quantity
Switch	1 pcs
AC Power Cord	1 pcs
Quick Installation Guide	1 pcs
Mats	4 pcs
WI-PS518GH   WI-PS526GH   WI-PS318GFH   WI-PS326GFH	
Items	Quantity
Switch	1 pcs
AC Power Cord	1 pcs
Rack Mount kit (Hooks × 2; Mats × 4; Screws × 8)	1 pcs
Quick Installation Guide	1 pcs



Wireless-Tek Technology Limited

Address: Biaofan Technology Building 402, Bao'an street,  
Baoan District, Shenzhen City, Guangdong, China

Website: [www.wireless-tek.com](http://www.wireless-tek.com)

Tel: 86-0755-32811290

Email: [sales@wireless-tek.com](mailto:sales@wireless-tek.com)

Technical Support: [tech@wireless-tek.com](mailto:tech@wireless-tek.com)



Technical Support



Cloud Management



Company Website