

## Datasheet

# 250 meters Long-Range PoE Switch for CCTV

WI-PS205 | WI-PS210 | WI-PS210G | WI-PS518G  
WI-PS526G

Hardware Version 4.0



## Overview

Complied with 802.3af/at/bt(Hi-PoE), Wi-Tek Long-Distance PoE Switch provide 4/8/16/24 10/100Mbps PoE RJ-45 ports, which can meet flexibly the demand of different PoE Input in different application scenarios. In addition, Wi-Tek Long-Distance PoE Switch can extend the data transmission distance to 250m, breaking the distance limit and improving the device availability. At the same time, Wi-Tek Long-Distance PoE Switch provide valuable features such as extend mode, PoE Watchdog, Port isolation, creating reliable network to grow your business.

## Features

### PoE 250m Long Distance to Extend Network

DIP switch provides Extend Mode. All PoE ports can transmit data and power up to 250 meters. No additional hardware or configuration is required, making it user-friendly and cost-effective. Perfect for surveillance camera deployment in large areas.

### Hi-PoE 60W Design for Higher Power PoE Devices

Hi-PoE switch is the upgraded version of PoE switch with higher PoE power. There are many emerging applications that take advantage of high-power PoE, such as building infrastructure with LED display, PTZ IP cameras, and other high power consumption devices.

### Smart PoE Watchdog to Reboot Camera Automatically

Watchdog is able to monitor status of camera in real-time. Once the camera stops working and does not respond to the switch, the switch will reboot the camera, making surveillance management easier.

### CCTV Mode Provide QoS Function

To ensure your network operates stably at peak performance, QoS is designed to assign priority to critical data on your network. To make it even easier, Wi-Tek's unmanaged switches include a DIP switch that can enable QoS with a simple switch flip.

### Port Isolation to Prevent Broadcast Storm

With VLAN Mode, all PoE ports only can communicate with uplink ports. Avoid data leakage between each port and prevent broadcast storm from disabling network.

# Specifications



| Model                          | WI-PS205   | WI-PS210  | WI-PS210G   |
|--------------------------------|--|---|---|
| <b>Hardware Specifications</b> |  |   |   |
| Hardware Version               | V4   | V4  | V4  |
| <b>Interfaces</b>              |  |   |   |
| Downlink Ports                 | 4 10/100Mbps RJ45<br>PoE Ports   | 8 10/100Mbps RJ45<br>PoE Ports  | 8 10/100Mbps RJ45<br>PoE Ports  |
| Uplink Ports                   | 2 10/100Mbps<br>Uplink Ports   | 2 10/100Mbps<br>Uplink Ports  | 2 100/1000Mbps<br>Uplink Ports  |
| <b>PoE</b>                     |  |   |   |
| PoE Port                       | Port 1–4   | Port 1–8  |   |
| PoE Standard                   | Port 1: 802.3bt 60W<br>Port 2–4:802.3af/at 30W   | Port 1: 802.3bt 60W<br>Port 2–8: 802.3af/at 30W                                   |   |
| PoE Power Supply Type          | Mid–span and End–span  |   |   |
| PoE Pin Assignment             | 1/2(+), 3/6(–) or 4/5(+), 7/8(–)   |   |   |
| PoE Power                      | 60 W max for port 1,<br>30W max for port 2–4,<br>60 W Max.<br>(PoE power budget)   | 60 W max for port 1,<br>30W max for port 2–8,<br>120 W Max.<br>(PoE power budget) | 60 W max for port 1,<br>30W max for port 2–8,<br>120 W Max.<br>(PoE power budget) |
| <b>Switch Property</b>         |  |   |   |
| Standards and Protocols        | IEEE 802.3 (Ethernet)<br>IEEE 802.3u (Fast Ethernet)<br>IEEE 802.3ab (Gigabit Ethernet)<br>IEEE 802.3af (Power over Ethernet)<br>IEEE 802.3at (Power over Ethernet Plus)<br>IEEE 802.3bt (Power over Ethernet Type 3 ) |   |   |
| Forwarding Mode                | Store and Forward  |   |   |
| Switching Capacity             | 1.2 Gbps   | 2 Gbps  | 5.6Gbps   |
| Packet Forwarding Rate         | 0.89Mpps   | 1.49Mpps  | 4.17Mpps  |
| MAC Address Table              | 2k   | 1k  | 8k  |
| Packet Buffer Memory           | 448 K bit  |   | 4Mbit   |
| Jumbo Frame                    | 1536Byte   |   | 9216Byte  |
| <b>Power Supply</b>            |  |   |   |
| Input Power                    | DC 48–56V 1.3A Max   | DC 48–56V 2.5A Max  | AC 100–240V, 50/60Hz<br>2.5A Max  |
| Power Consumption              | Idle: 0.63W 100% Traffic<br>Rate with PoE: 70.5 W  | Idle: 1.06W 100% Traffic<br>Rate with PoE: 129.05W                                | Idle: 1.83W 100% Traffic<br>Rate with PoE: 135.6W                                 |



| Model                           | WI-PS205   | WI-PS210  | WI-PS210G   |
|---------------------------------|--|---|---|
| <b>Physical Characteristics</b> |  |   |   |
| LED Indicators                  | <p><b>PWR</b><br/>Solid on: The device power on is normal<br/>Off: The device is power off or failed</p> <p><b>PoE</b><br/>On: PoE is working<br/>Off: PoE not working</p> <p><b>Link</b><br/>On: Data on TX/RX<br/>Off: Ports link down<br/>PoE Max<br/>When total PoE output power &gt; Power Budget * 80%, the LED light will be on</p>   |   | <p><b>PWR</b><br/>Solid on: The device power on is normal<br/>Off: The device is power off or failed</p> <p><b>PoE</b><br/>On: PoE is working<br/>Off: PoE not working</p> <p><b>LNK/ACT</b><br/>On: Data on TX/RX<br/>Off: Ports link down</p> |
| Buttons                         | <p><b>Default</b><br/>The transmission distance of PoE Port can be up to 100m with 100Mbps and disable port VLAN, QoS, Watchdog</p> <p><b>VLAN</b><br/>Enable Port VLAN and Watchdog, each PoE port just can send data to Up-link port , PoE transmit 100 meters and disable QoS</p> <p><b>CCTV=250m PoE+VLAN+QoS</b><br/>Enable Port VLAN, PoE transmit 250 meters and enable QoS, Watchdog</p> |   |   |
| Fan Quantity                    | Fanless  |   |   |
| Switch Dimensions               | 140.0x76.7x27.7 mm   | 168.0x94.0x32.0 mm  | 220.0x150.0x44 mm   |
| Package Dimensions              | 193.0x203.0x62.0 mm  | 195.0x201.0x62.0 mm   | 315.0x202.0x82.0 mm   |
| Weight                          | Net Weight: 0.32 kg  | Package Weight: 0.47 kg                                     | Net Weight: 1.75 kg   |
|                                 | Package Weight: 0.60 kg  | Net Weight: 0.77 kg   | Package Weight: 2.37 kg   |
| Installation                    | Wall-mounted, Desktop  |   | Wall-mounted, Desktop, Rack-mount   |
| <b>Environmental</b>            |  |   |   |
| Reliability                     | Surge Immunity   | IEC 61000-4-5<br>Common mode 4kV<br>Differential mode 2kV   |   |
| Reliability                     | ESD Protection   | IEC 61000-4-2<br>Contact discharge 6kV<br>Air discharge 8kV |   |
| Operating Temperature           | -10°C-50°C (14°F-122°F)  |   |   |
| Storage Temperature             | -40°C-70°C (-40°F-158°F)   |   |   |
| Operating Humidity              | 10-90% RH non-condensing   |   |   |
| Storage Humidity                | 5-95% RH non-condensing  |   |   |
| <b>Certification</b>            |  |   |   |
| Certification                   | CE, FCC, RoHS, UKCA, RCM   |   |   |



| Model                          | WI-PS518G  | WI-PS526G  |
|--------------------------------|--|--|
| <b>Hardware Specifications</b> |  |  |
| Hardware Version               | V4   | V4   |
| <b>Interfaces</b>              |  |  |
| Downlink Ports                 | 16 10/100Mbps RJ45 PoE Ports   | 24 10/100Mbps RJ45 PoE Ports   |
| Uplink Ports                   | 1*1000M Combo SFP Port   | 2*1000M Combo SFP Ports  |
| <b>PoE</b>                     |  |  |
| PoE Port                       | Port 1–16  | Port 1–24  |
| PoE Standard                   | Port 1–2: 802.3bt 60W<br>Port 3–16:802.3af/at 30W  | Port 1–2: 802.3bt 60W<br>Port 3–24:802.3af/at 30W                          |
| PoE Power Supply Type          | Mid–span and End–span  |  |
| PoE Pin Assignment             | 1/2(+), 3/6(–) or 4/5(+), 7/8(–)   |  |
| PoE Power                      | 60W Max. for port1–2, 30 W for port3–16, 185 W Max. for PoE power budget   | 60 W Max. for port1–2, 30 W for port 3–24, 250 W Max. for PoE power budget |
| <b>Switch Property</b>         |  |  |
| Standards and Protocols        | IEEE 802.3 (Ethernet)<br>IEEE 802.3u (Fast Ethernet)<br>IEEE 802.3ab (Gigabit Ethernet)<br>IEEE 802.3af (Power over Ethernet)<br>IEEE 802.3at (Power over Ethernet Plus)<br>IEEE 802.3bt (Power over Ethernet Type 3 ) |  |
| Forwarding Mode                | Store and Forward  |  |
| Switching Capacity             | 7.2 Gbps   | 8.8 Gbps   |
| Packet Forwarding Rate         | 5.4 Mpps   | 6.5 Mpps   |
| MAC Address Table              | 8 k  |  |
| Packet Buffer Memory           | 4Mbit  |  |
| Jumbo Frame                    | 9216Byte   |  |
| <b>Power Supply</b>            |  |  |
| Input Power                    | AC:100–240V~50/60Hz 5A Max   |  |
| Power Consumption              | Idle: 4.975 W<br>100% Traffic Rate with PoE: 198.6 W   | Idle: 7.11 W<br>100% Traffic Rate with PoE: 282.9 W                        |



| Model                    | WI-PS518G   | WI-PS526G   |
|--------------------------|---|---|
| Physical Characteristics |   |   |
| LED Indicators           | <p><b>PWR</b><br/>Solid on: The device power on is normal<br/>Off: The device is power off or failed</p> <p><b>PoE</b><br/>On: PoE is working<br/>Off: PoE not working</p> <p><b>LNK/ACT</b><br/>On: Data on TX/RX<br/>Off: Ports link down</p> <p><b>PoE Max</b><br/>When total PoE output power &gt; Power Budget * 80%, the LED light will be on</p> <p><b>17T/17S</b><br/>On:Port 17T/17S link up<br/>Off:Port 17T/17S link down</p> <p><b>18T</b><br/>On:Port 18T link up<br/>Off:Port 18T link down</p> | <p><b>PWR</b><br/>Solid on: The device power on is normal<br/>Off: The device is power off or failed</p> <p><b>PoE</b><br/>On: PoE is working<br/>Off: PoE not working</p> <p><b>LNK/ACT</b><br/>On: Data on TX/RX<br/>Off: Ports link down</p> <p><b>25T/S(LNK/ACT)</b><br/>On:Port 25T/S link up<br/>Off:Port 25T/S link down</p> <p><b>25T/S(Speed)</b><br/>On: The negotiate speed is 1000Mbps and ports link up<br/>Off: The negotiate speed is 10/100Mbps, not 1000Mbps</p> <p><b>26T/S(LNK/ACT)</b><br/>On:Port 26T/S link up<br/>Off:Port 26T/S link down</p> <p><b>26T/S(Speed)</b><br/>On: The negotiate speed is 1000Mbps and ports link up<br/>Off: The negotiate speed is 10/100Mbps, not 1000Mbps</p> |
| Buttons                  | <p><b>Default</b><br/>The transmission distance of PoE Port can be up to 100m with 100Mbps and disable port VLAN, QoS, Watchdog</p> <p><b>VLAN</b><br/>Enable Port VLAN and Watchdog, each PoE port just can send data to Up-link port , PoE transmit 100 meters and disable QoS</p> <p><b>CCTV=250m PoE+VLAN+QoS</b><br/>Enable Port VLAN, PoE transmit 250 meters and enable QoS, Watchdog</p>  |   |
| Fan Quantity             | 1   | 2   |
| Switch Dimensions        | 280.0x180.0x44 mm   | 440.0x207.0x44 mm   |
| Package Dimensions       | 375.0x232.0x79.4 mm   | 492x316.7x72.0 mm   |
| Weight                   | Net Weight: 1.78 kg   | Net Weight: 2.80 kg   |
|                          | Package Weight: 2.41 kg   | Package Weight: 3.45 kg   |
| Installation             | Desktop, Rack-mounted   |   |



| Model                 |                          | WI-PS518G   | WI-PS526G |
|-----------------------|--------------------------|---|-----------|
| Environmental         |                          |   |           |
| Reliability           | Surge Immunity           | IEC 61000-4-5<br>Common mode 4kV<br>Differential mode 2kV     |           |
| Reliability           | ESD Protection           | IEC 61000-4-2<br>Contact discharge 6 kV<br>Air discharge 8 kV |           |
| Operating Temperature | -10°C-50°C (14°F-122°F)  |   |           |
| Storage Temperature   | -40°C-70°C (-40°F-158°F) |   |           |
| Operating Humidity    | 10-90% RH non-condensing |   |           |
| Storage Humidity      | 5-95% RH non-condensing  |   |           |
| Certification         |                          |   |           |
| Certification         | CE, FCC, RoHS, UKCA, RCM |   |           |



# Appearances and Dimensions

WI-PS205

Dimensions (mm)

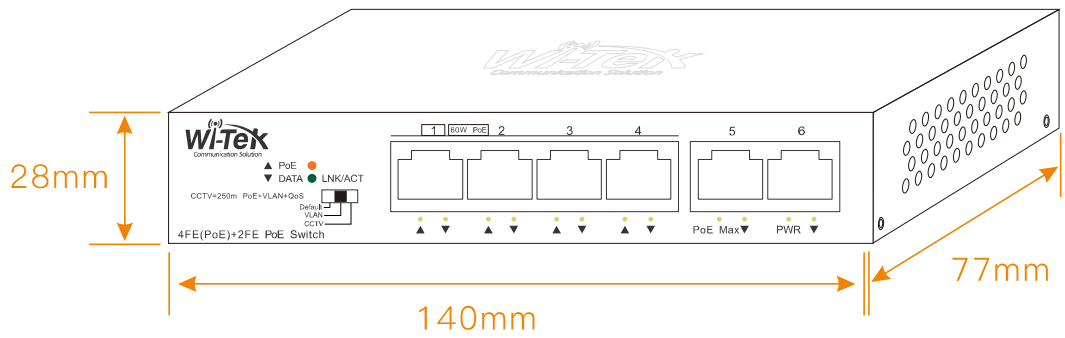

Front Panel

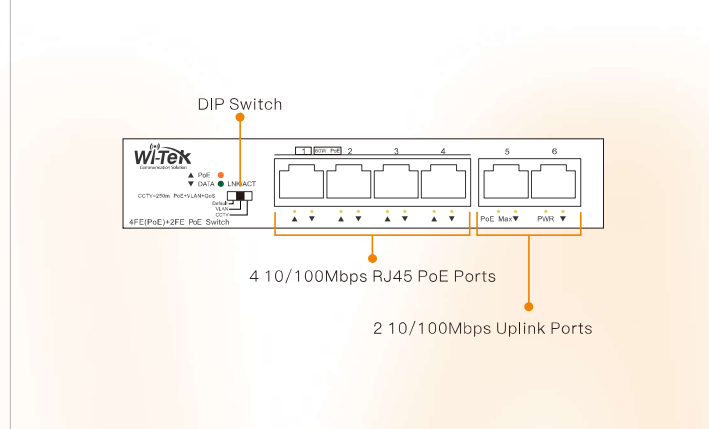

Rear Panel

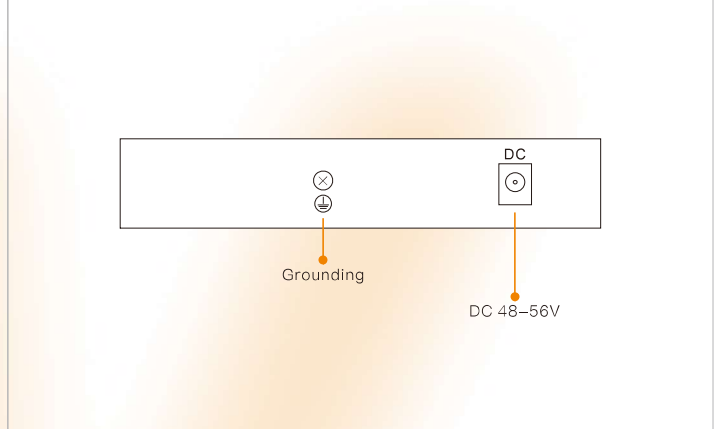

WI-PS210

Dimensions (mm)

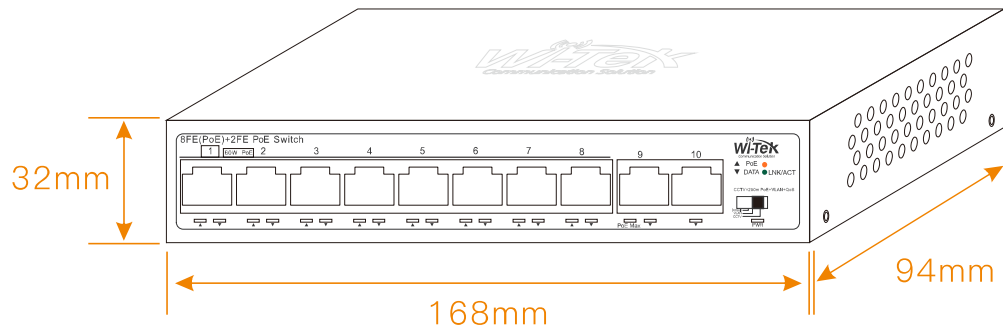

Front Panel

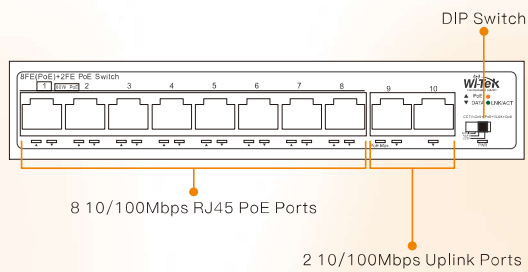

Rear Panel

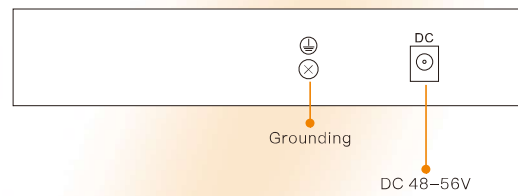



WI-PS210G

Dimensions (mm)

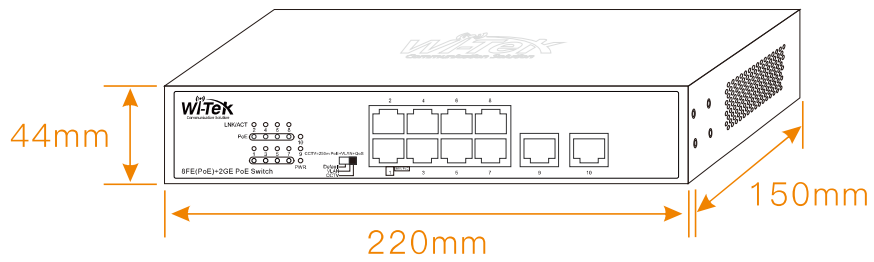

Front Panel

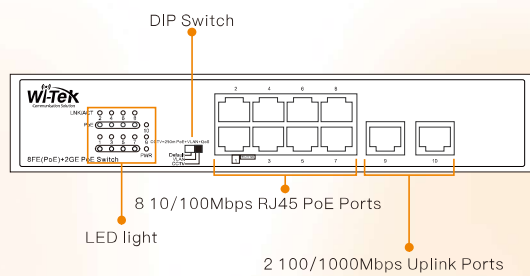

Rear Panel



WI-PS518G

Dimensions (mm)

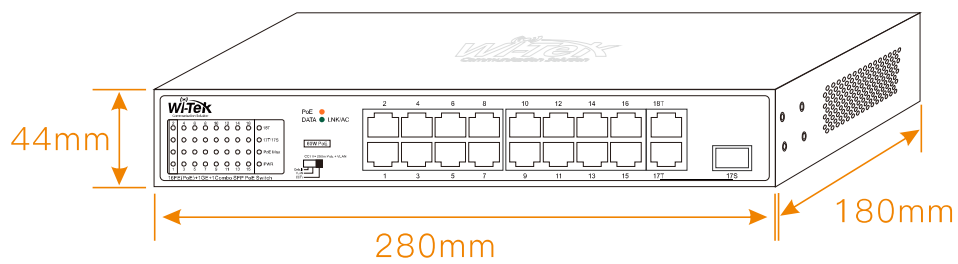

Front Panel

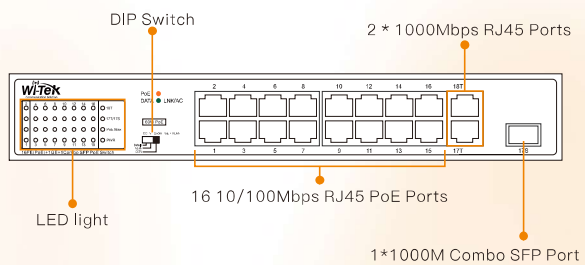

Rear Panel

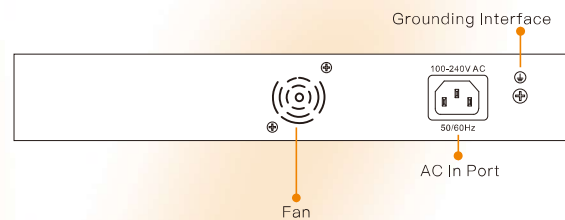

WI-PS526G

Dimensions (mm)

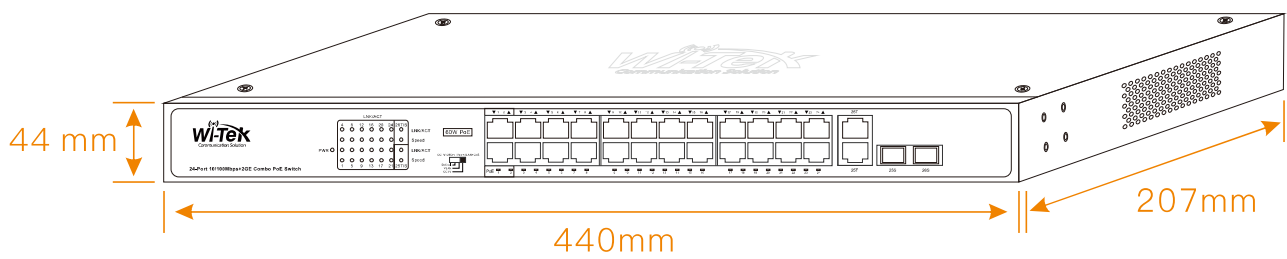

Front Panel

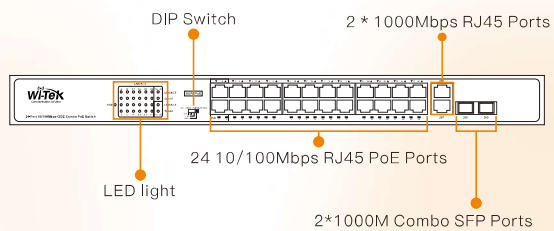

Rear Panel

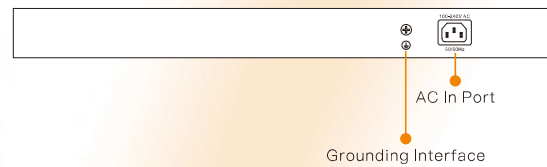

## Package Contents

Welcome to order our products. After purchasing, you will receive:

| WI-PS205   WI-PS210   WI-PS210G |          |
|---------------------------------|----------|
| Items                           | Quantity |
| Switch                          | 1 pcs    |
| Power Cord                      | 1 pcs    |
| Power Adapter                   | 1 pcs    |
| Quick Installation Guide        | 1 pcs    |

| WI-PS518G   WI-PSPS526G                          |          |
|--|----------|
| Items  | Quantity |
| Switch   | 1 pcs    |
| Power Cord                                       | 1 pcs    |
| Rack Mount kit (Hooks × 2; Mats × 4; Screws × 8) | 1 pcs    |
| Quick Installation Guide                         | 4 pcs    |



Wireless-Tek Technology Limited  
 Address: Biaofan Technology Building 402, Bao'an street,  
 Baoan District, Shenzhen City, Guangdong, China  
 Website: [www.wireless-tek.com](http://www.wireless-tek.com)  
 Tel: 86-0755-32811290  
 Email: [sales@wireless-tek.com](mailto:sales@wireless-tek.com)  
 Technical Support: [tech@wireless-tek.com](mailto:tech@wireless-tek.com)



Technical Support



Cloud Management



Company Website